

NEW
PRODUCT!

ASM90-TD15

Shoulder Milling



Achteck is launching a new positive shoulder milling tool for light cutting.

The triangle insert has MM3 and MM4 geometries, combined with CVD and PVD coating, can get better performance and surface quality. It's suitable for machining steel, stainless steel, cast iron, super alloy and other materials.

◆ Insert Introduction

Insert Features:

- Positive milling insert
- Three cutting edges, economic choice
- Positive rake angle and spiral angle design, light cutting
- Insert with short wiper
- M and H class insert to choose

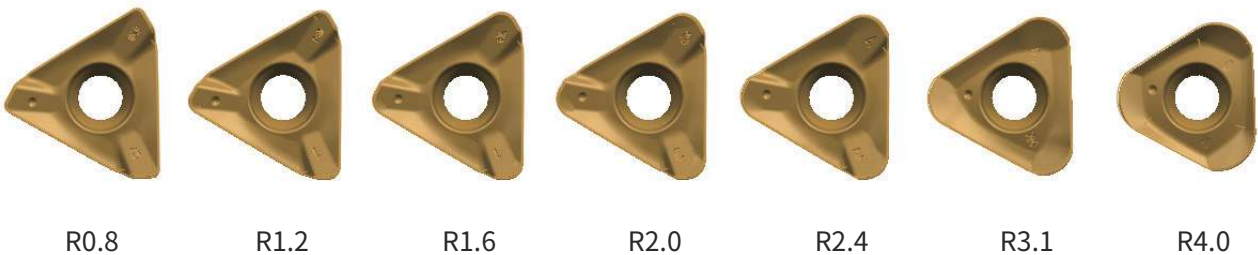
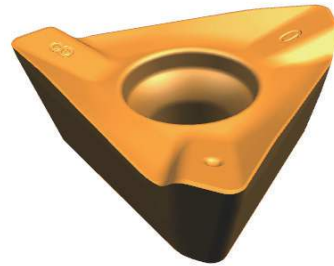

◆ Insert Type

- Radius range: R0.8, R1.2, R1.6, R2.0, R2.4, R3.1, R4.0
- Geometry: MM4, MM3, FM2
- Grade: AP301U, AP351M, AP403M, AC301K, AP351K

• **ASM90-TD15 Cutter introduction**



- Application range: Can be used for shoulder milling, face milling, slot milling, ramping, helical interpolate milling;
- Good Universality: Can be used for steel, cast iron, stainless steel roughing and semi-finishing milling;
- Two kinds of coupling:
Cylindrical shank: $\phi 32-40\text{mm}$
Shell mill(Arbor): $\phi 40-200\text{mm}$



• **ASM90-TD15 Cutter introduction**

When big corner radius inserts are used, the tool body needs to be modified

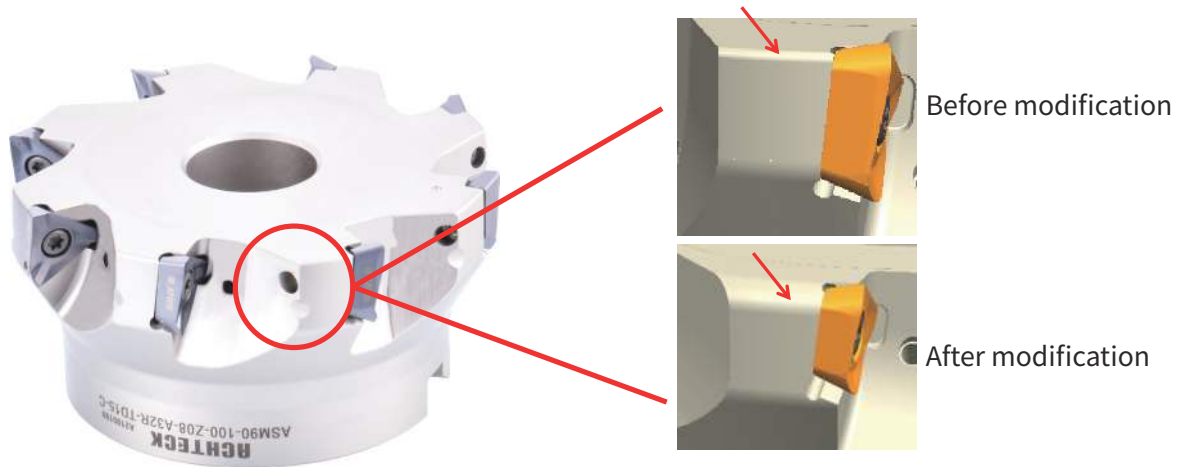

TDMT 150531R-MM4	Modify the tool body corner radius to R2.0
TDMT 150540R-MM4	Modify the tool body corner radius to R4.0

• **Geometry introduction**

Insert	Geometry	Cutting edge	Application Range
	MM4		<ul style="list-style-type: none"> · For medium cutting conditions · 1st choice for general machining
	MM3		<ul style="list-style-type: none"> · For good cutting conditions, finishing · Low cutting force, can be used for low-power machines
	FM2		<ul style="list-style-type: none"> · Sharp geometry · Low cutting force · Used for aluminum machining

◆ **ASM90-TD15 Application Parameter Recommendation**

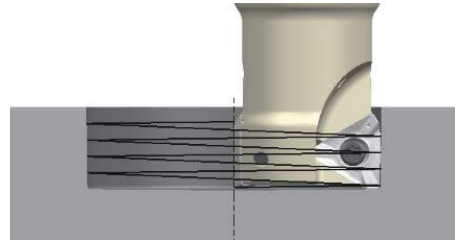
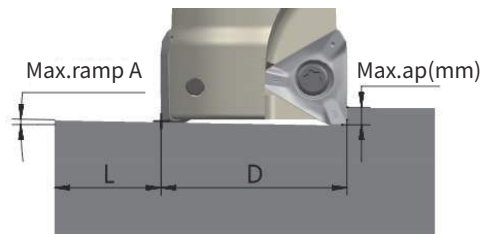

Cutter dia (mm)	Straight ramp down			Helical interpolation		
	Max.ramp (°)	Min.length (mm)	Max ap (mm)	Min dia (mm)	Max dia (mm)	Max pitch (mm)
32	1.4	479	11.5	53.5		1.4
	1.4	479	11.5		64.0	2.1
40	1.0	633	11.5	70.1		1.5
	0.7	957	11.5		80.0	1.3
50	0.8	824	11.5	90.1		1.5
	0.8	824	11.5		100.0	1.9
63	0.6	1073	11.5	116.1		1.5
	0.6	1073	11.5		126.0	1.8
80	0.5	1399	11.5	150.3		1.5
	0.5	1399	11.5		160.0	1.8
100	0.3	2144	11.5	190.5		1.3
	0.3	2144	11.5		200.0	1.4
125	0.3	2262	11.5	240.3		1.6
	0.3	2262	11.5		250.0	1.7
160	0.2	2933	11.5	310.3		1.6
	0.2	2933	11.5		320.0	1.7
200	0.2	3692	11.5	390.3		1.6
	0.2	3692	11.5		400.0	1.7

• **TD15 Insert**

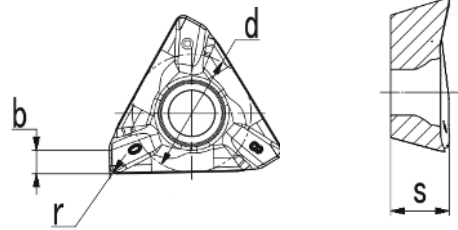

Product code	Dimensions				Grades								
	d	b	s	r	AP301U	AC301P	AP351U	AP403M	AP351M	AC301K	AP351K	AP403S	AW100K
TDMT 150508R-MM4	11.40	1.49	5.6	0.8	●			●	●	●	●		
TDMT 150512R-MM4	11.40	1.0	5.6	1.2	●			●	●	●	●		
TDMT 150516R-MM4	11.40	0.93	5.6	1.6	●			●	●	●	●		
TDMT 150520R-MM4	11.40	0.71	5.6	2.0	●			●					
TDMT 150524R-MM4	11.40	0.59	5.6	2.4				●					
TDMT 150531R-MM4	11.40	0.4	5.56	3.1				●					
TDMT 150540R-MM4	11.40	0.4	5.56	4.0				●					
TDMT 150508R-MM3	11.40	1.49	5.56	0.8	●			●	●				
TDHT 150508R-MM4	11.40	1.5	5.6	0.8	●			●	●				

● Stocked item

• **ASM90-TD15 Cutter**

Cylindrical shank

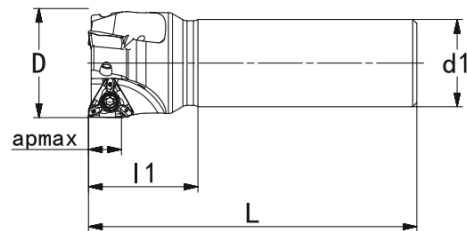
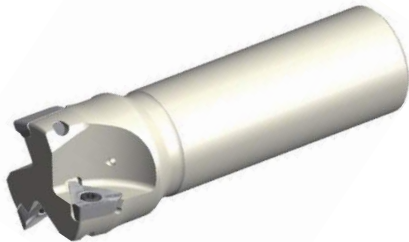

Product code	D	d1	L	L1	apmax	Coolant	Z	Insert
ASM90-032-Z02-C32R-TD15-C	32	32	110	40	11		2	TD..1505..
ASM90-032-Z02-C32R-TD15-L200-C	32	32	200	40	11		2	
ASM90-040-Z03-C32R-TD15-C	40	32	120	40	11		3	
ASM90-040-Z03-C32R-TD15-L200-C	40	32	200	40	11		3	

Shell mill arbor

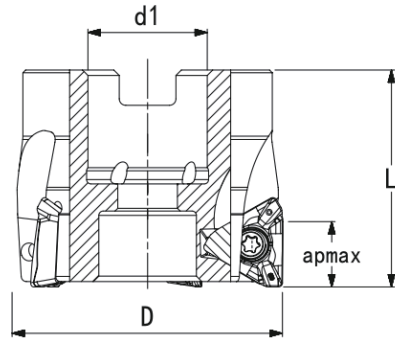

Product code	D	d1	L	apmax	Coolant	Z	Insert
ASM90-040-Z04-A16R-TD15-C	40	16	40	11		4	TD..1505..
ASM90-050-Z04-A22R-TD15-C	50	22	40	11		4	
ASM90-050-Z05-A22R-TD15-C	50	22	40	11		5	
ASM90-063-Z04-A22R-TD15-C	63	22	40	11		4	
ASM90-063-Z05-A22R-TD15-C	63	22	40	11		5	
ASM90-063-Z06-A22R-TD15-C	63	22	40	11		6	
ASM90-080-Z05-A27R-TD15-C	80	27	50	11		5	
ASM90-080-Z06-A27R-TD15-C	80	27	50	11		6	
ASM90-080-Z07-A27R-TD15-C	80	27	50	11		7	
ASM90-100-Z06-A32R-TD15-C	100	32	50	11		6	
ASM90-100-Z08-A32R-TD15-C	100	32	50	11		8	
ASM90-125-Z07-A40R-TD15-C	125	40	63	11		7	
ASM90-125-Z09-A40R-TD15-C	125	40	63	11		9	
ASM90-160-Z08-A40R-TD15	160	40	63	11		8	
ASM90-160-Z10-A40R-TD15	160	40	63	11		10	
ASM90-200-Z09-A60R-TD15	200	60	63	11		9	
ASM90-200-Z11-A60R-TD15	200	60	63	11		11	

Dimension	Spare Parts			
Cutter diameter	Screw	Wrench		Torque
φ32-200				3.5Nm
	SP040100H	DT-TP15		
Product code	Mounting bolt	Bolt	Screw wrench	Wrench
ASM90-040-Z04-A16R-TD15-C		WD080300		LT-H4

◆ **Case Stories-01**

Workpiece name: Pump body
 Material: GG25
 Insert: TDMT 150508R-MM4 AC301K
 Cutter: ASM90-050-Z05-A22R-TD15-C
 Machining position: Milling surrounding plane
 Parameter: Vc=280m/min, ap=0.5mm, fz=0.3
 Coolant: Wet cutting

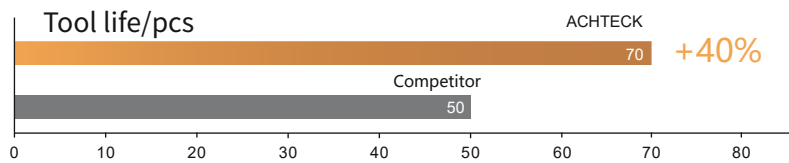

Test result: Achteck tool life is 40% higher than the competitor

◆ **Case Stories-02**

Workpiece name: Track
 Material: E235B
 Insert: TDMT 150508R-MM4 AP301U
 Cutter: ASM90-100-Z08-A32R-TD15-C
 Machining position: Milling track face
 Parameter: Vc=200m, ap=0.5mm, fz=0.12
 Coolant: Wet cutting

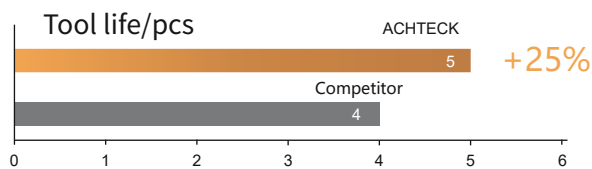

Test result: Achteck tool life is 25% higher than the competitor